

MATRIX. IMAGINE THE POSSIBILITIES.



Executive Interiors



ExecutiveInteriors.com

IMPRESS FOR LESS.

For sophistication and functionality. For versatility. For a completely customizable, surprisingly cost-effective panel system that meets the wide-ranging demands of today's office environments, choose Matrix. Tailor it to your needs, your tastes. Impress for less.

FINISHES:

Paint: Lite Silver Smooth

Fabrics: Guilford -

Phone Tag, Color: Limeade

Guilford -

Phone Tag, Colors: Skydive

Laminate: Formica - Peaseful Blue in
Microdot finish





OFF-MODULARITY MEETS FUNCTIONAL DESIGN.

Introduce Matrix to your office environment, and get a long-term solution to space management needs. Matrix is ideal for integrating Off-Modular components for optimal space planning and flexible reconfiguration. With an Off-Modular configuration, you can create footprints of various sizes in the field without disrupting neighboring workstations. Off-Modular panels are easy to integrate around structural poles and tombstone electrical areas in floors. You can also use them in those difficult long runs where you need structural support. With flipper doors, shelves and other components, accessories and storage options available in various sizes, Matrix lets you integrate them just about anywhere, no matter the space limitations. Design around difficult space restrictions and perfectly meet your needs.

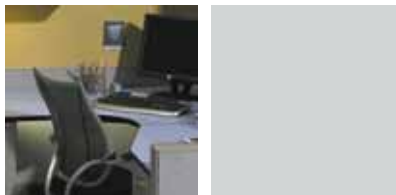
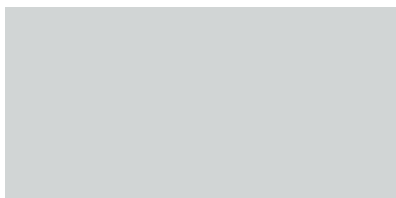
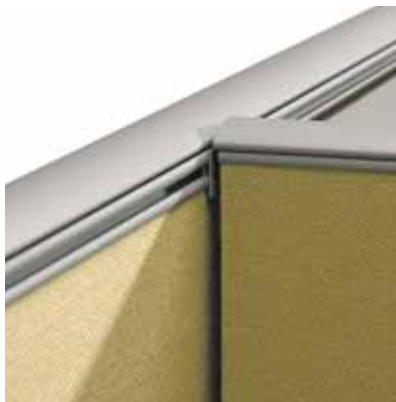
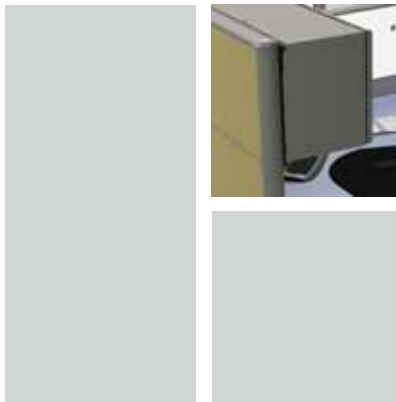

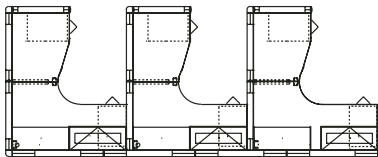

FINISHES:

Paint: Lite Silver Smooth

Fabrics: Guilford - Phone Tag, Color: Limeade

Guilford - Phone Tag, Color: Skydive

Laminate: Formica - Peaseful Blue in Microdot finish

**SHED SOME LIGHT ON
ANY SUBJECT.**

Matrix. This is a system that can not only improve your office environment's appearance, but also its impact on people. Simply add glass –we offer a range of types—to your Matrix system, and you'll boost the light radiated throughout the office. This can help boost your employees' productivity, health and outlook.

FINISHES:

Paint: Lite Silver Smooth
Fabric: Guilford - Color: Groove Mist
Laminate: Formica - Dune Wood
Glass Type: Clear, Spraylight

ExecutiveInteriors.com



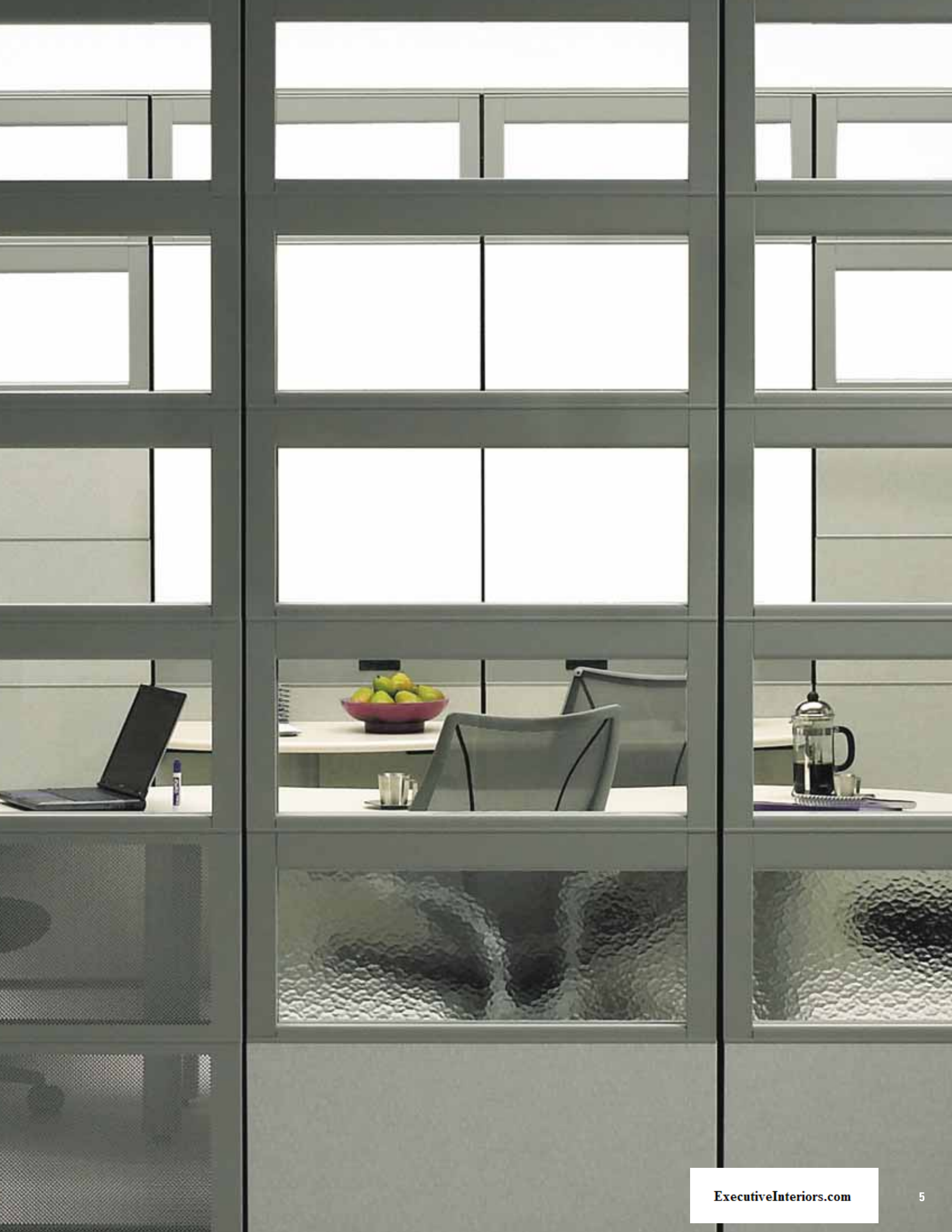

BE OPEN. BE BEAUTIFUL.

The key word with Matrix is, indeed, flexibility. Create a warm, upscale and stunning environment. Or design something simple and clean. Matrix allows you to efficiently, easily develop virtually any style and size of workspace. Our full-frame design and tile-mounting system means you'll face fewer challenges when you confront a new footprint or task. Simply choose the tiles you need—they're available in sizes of 8" to 64" and 11 different styles.

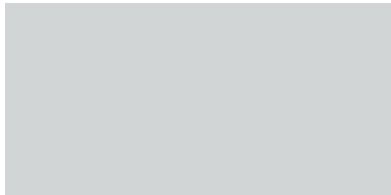

- 1 Integrate tool rails and accessories for ease of use.
- 2 Power can be placed in 8" height increments to accommodate various needs.
- 3 Four different glass types are available.



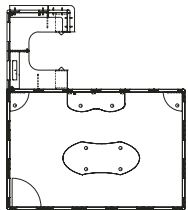

Matrix creates a truly segmented look.

- FINISHES:**
Paint: Lite Silver Smooth
Fabric: Guilford - Color: Groove Mist
Laminate: Formica - Dune Wood
Glass Type: Clear, Spraylight

WORK OUTSIDE THE BOX.

Move your organization beyond traditional square and rectangular configurations to a world of unparalleled productivity. Use Matrix to create 120-degree configurations, giving workers greater privacy and visual separation while still encouraging them to work together—a sure way to boost productivity and creativity.

- 1 Integrate curvilinear worksurfaces for increased employee ergonomics.
- 2 Worksurfaces of various shapes can be used to maximize workspace.
- 3 120 space planning offers employees privacy, yet the ability to work as a team easily.
- 4 120 degree connections can be used in varying applications to maximize space and offer an increased aesthetic.

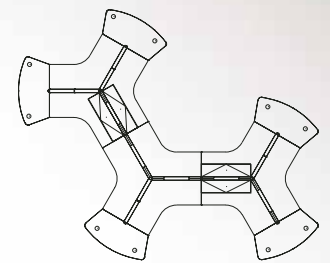
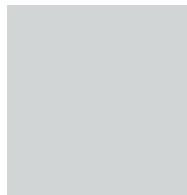
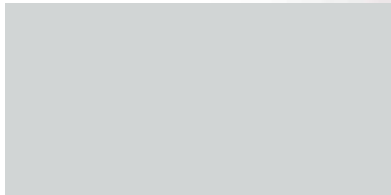
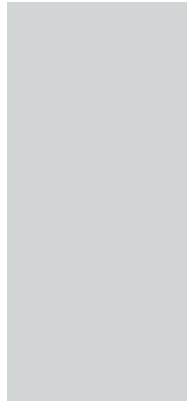
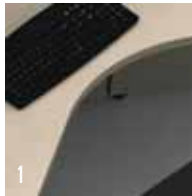
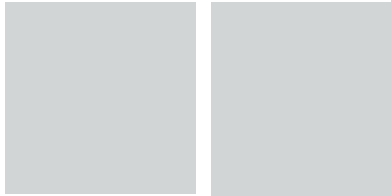

FINISHES:

- Paint: Light Tone
- Station Fabric: DesignTex - Cut to the Chase, Color: Alabaster.
- Laminate: Formica - Pionite Rocky Mountain High
- Flipper Door Fabric: DesignTex - Kensho, Color: Mango







SIMPLE. STUNNING. CHOICES.

With Matrix, the look is up to you.

Choose from an array of colors and fabrics, laminates and paint finishes.

Mix and match. Or create a single, powerful design. It's your choice. The options are all here.

FINISHES:

Paint: Morning Dew

Fabrics: Jhane Barnes Textiles - Opening Night, Colors: Tango & Big Screen.

Laminate: Formica - Flax Gauze

Glass: Clear

**TEAM UP.
WORK SMARTER.**

It's a fact that teaming boosts productivity. The Matrix system enables you to customize each work environment to meet the tastes and needs of every team in your office. With electrical and data capacity running every eight inches of the system's frame, and a range of work surface sizes and styles, you can adapt Matrix to virtually any environment. Planning for the future is easy, too, thanks to forward-thinking features that include Quad electrical tiles—electrical tiles above or below work surface height—and data jacks.



1

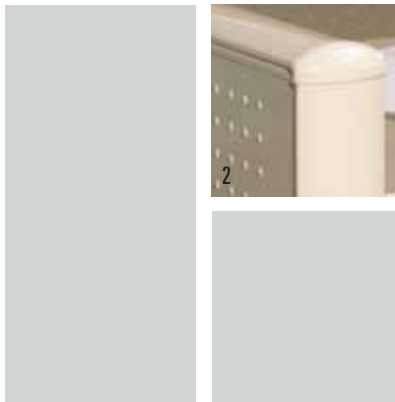

2



3

- 1 Choose from over 60 Grade A Quick Ship Laminates, 120 Fabrics and 9 Paint finish options to have your office in 10 working days or less.
- 2 Matrix offers a rounded panel trim for increased enhanced aesthetic.
- 3 Data/phone jack modules, in a variety of combinations can be mounted anywhere in 8" increments on the panel frame.

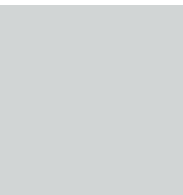
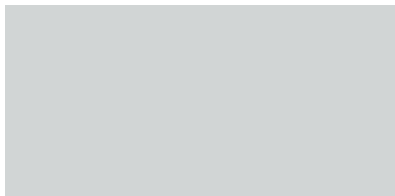

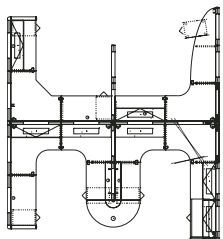

Panels are available in 6 heights, 6 widths, and 3 stack-on height options for a total available height of 130".

FINISHES:

- Paint: Morning Dew
- Fabrics: Jhane Barnes Textiles - Opening Night,
Colors: Tango & Big Screen.
- Laminate: Formica - Flax Gauze
- Glass: Clear

UNLEASH THE POWER

The Matrix electrical system has more capacity and design flexibility of virtually any frame and tile system available today. Matrix provides electrical and data cabling holes at every 8" of height, forming up to 10 laterally continuous raceway channels on an 82" high panel. Electrical and data may be snaked through the panel frames at every height, and multiple powerways can be positioned from the bottom of the panel up to 114" in height providing extensive cabling capacity and power access placement options. Power and data can be consolidated in single power tile offering up to 3 duplexes and 8 data jack housings in a single location.





LEGEND

- A Single Powerway Assembly at Base
- B Fiber Optic Bundle
- C Category 6 Data Cables
- D Double Powerway Assemblies Below Worksurface
- E Single Powerway Assembly in Overhead
- F Topcap Lay-in Channel
- G Triple Channel Pole
- H Single Powerway at Beltline
- I Shielded Metal Trough for Secure Data

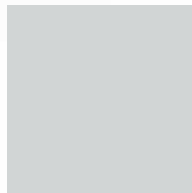

UNLEASH THE VALUE.

1. Powerways providing access to an 8 wire 4 circuit electrical system may be mounted at any height from base to beltline or above. Every 8-inch power access tile can accommodate two powerways stacked to allow access for up to 4 duplex outlets and/or data jack housings.
2. A true unimpeded "lay in" topcap channel accommodates up to 40 category 6 cables in addition to the 8" increment lateral channels. Stack frames may be retrofit over lay in channel without removing existing cables. Matrix sets a new industry standard for electrical and data capacity, flexibility and access.
3. A triple channel powerpole provides multiple power and data separation options.

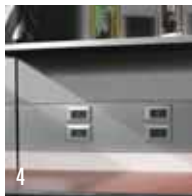

- 4 Quad power tile above worksurface height.
- 5 Quad power and data combination tile above worksurface height.
- 6 Non powered steel tile at base raceway height
- 7 Quad power and data tile below the worksurface
- 8 Dual power tile at raceway height





ENHANCED STORAGE & COMPONENT OPTIONS



Escape from the traditional flat-front overhead storage design with the Radius overhead unit. Offered in both solid or perforated steel patterns, with an available easy-down mechanism, the Radius overhead adds an element of style and design that compliments the radius shape of the Matrix panel trim.



Panel mounted sliding doors are a perfect way to create a semi-private office environment using standard height panels.

Available for 36", 42" and 48" width openings, and 66" and 82" heights, the ultra light aluminum screen frame, and durable transparent nylon glide wheel result in a user-friendly and practical design. The universal design mounts to the left or right, front or back of the panel. A variety of standard opaque and semi-opaque screen styles are available, as well a standard insert design that makes the use of COM materials a snap.

ENDLESS TILE CONFIGURATIONS

Want a monolithic look? Use our tackable/acoustical fabric tiles to create it. They're available in a broad range of heights—from 8" to 64". Or take your design in a totally different direction. We offer other tiles in heights of 8", 16" or 24"; they're available in painted steel, perforated (Airflow), embossed steel, laminate, veneer, tool rails, whiteboard, open frame, electrical access and tempered glass (with two different standard colors and patterns). All are front-mounting and can be individually removed without disturbing the tiles above or below.



TOOL RAIL
 Heights: 8"
 Widths: 24" - 48" in 6" increments

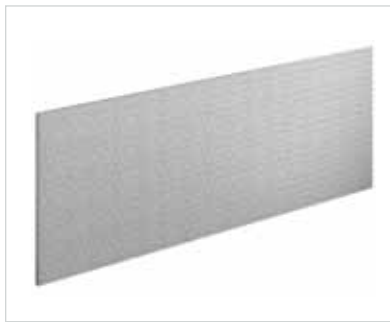

TACKABLE ACOUSTICAL FABRIC
 Heights: 8" - 64" in 8" increments
 Widths: 24" - 48" in 6" increments



GLASS OR ACRYLIC
 Heights: 16" and 24"
 Widths: 24" - 48", in 6" increments



PASS-THROUGH OPEN FRAME
 Heights: 16" and 24"
 Widths: 24" - 48", in 6" increments

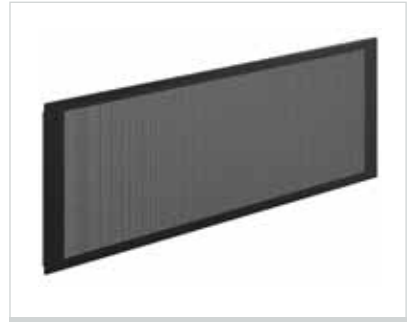

PERFORATED "AIR-FLOW" STEEL
 Heights: 16" and 24"
 Widths: 24" - 48", in 6" increments



WHITEBOARD
 Heights: 16" and 24"
 Widths: 24" - 48", in 6" increments



LAMINATE OR VENEER
 Heights: 8", 16", and 24"
 Widths: 24" - 48", in 6" increments



EMBOSSED STEEL
 Heights: 16" and 24"
 Widths: 24" - 48", in 6" increments



SOLID STEEL
 Heights: 8", 16", and 24"
 Widths: 24" - 48", in 6" increments



QUAD POWER, DATA OR COMBINATION
 Heights: 8"
 Widths: 24" - 48" in 6" increments

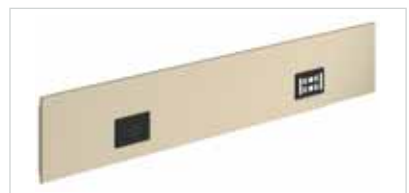

DUAL POWER, DATA OR COMBINATION
 Heights: 8"
 Widths: 24" - 48" in 6" increments

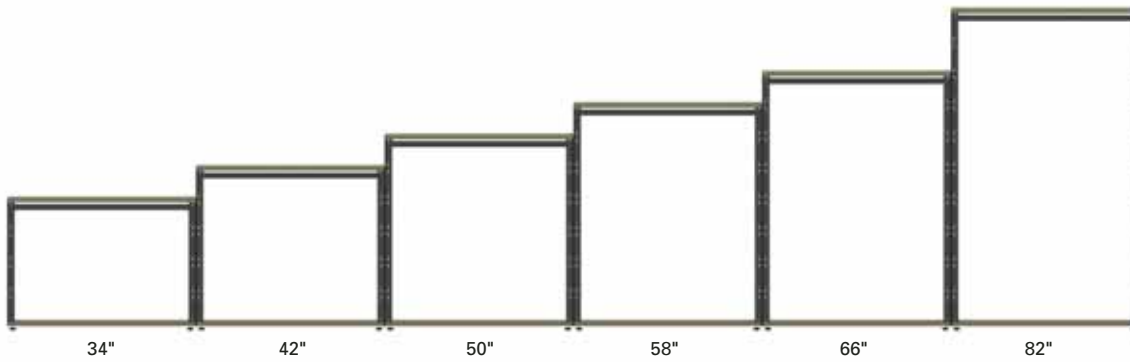

PANEL FRAME SIZES

**FRAME AND TILE.
STRONG AND EASY.**

Rigid, welded roll-formed steel frame construction. Six full-frame panel widths. Six full-frame heights. Three structural stacking extension choices and floor-to-ceiling components. It all adds up to one solid system that adapts to any floor plan.

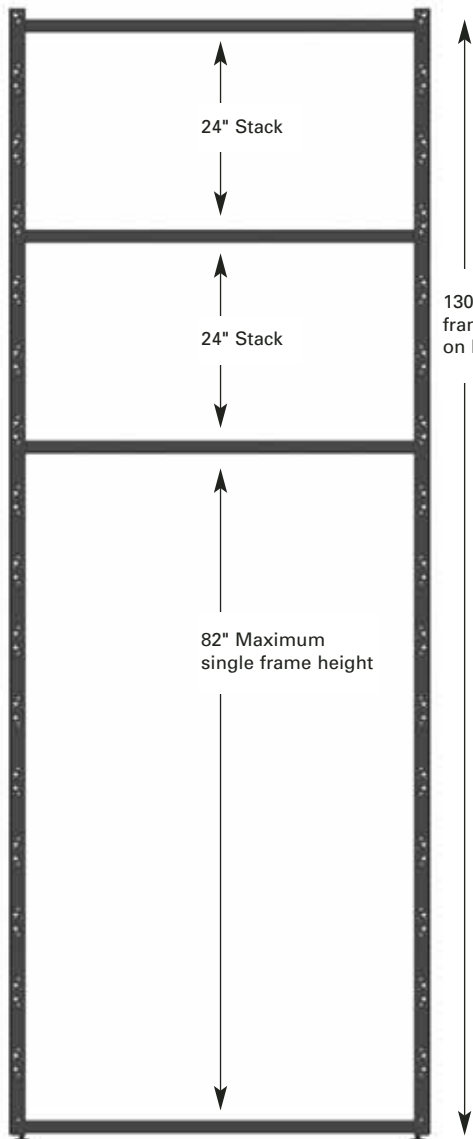

CONNECTION AND
TILE RETAINING SYSTEM

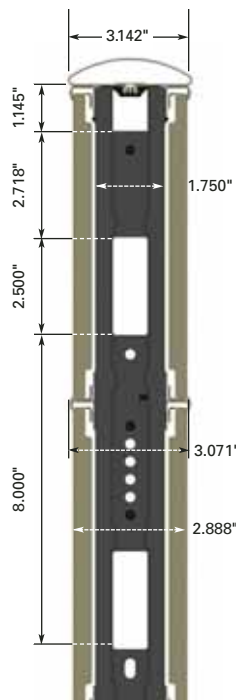

PANEL PROFILE

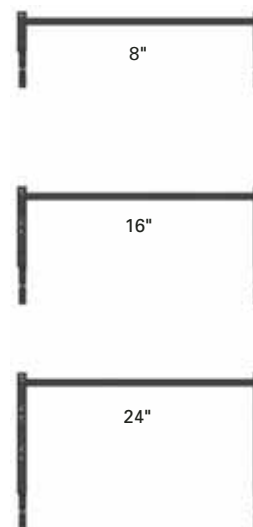

STACK ONS

STORAGE AND FILE SOLUTIONS

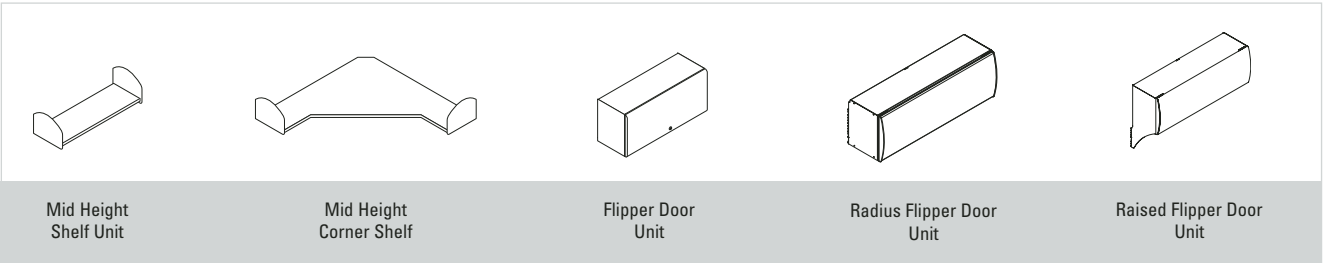

SHELVES / FLIPPER DOORS

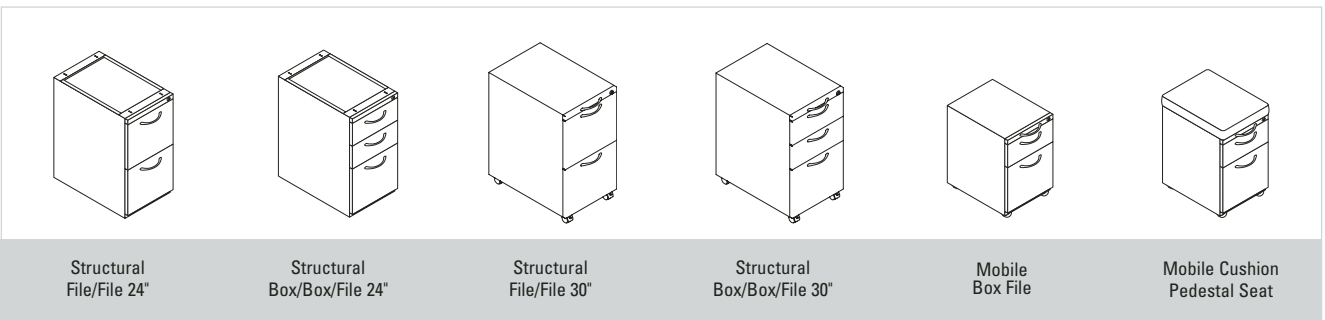

PEDESTALS

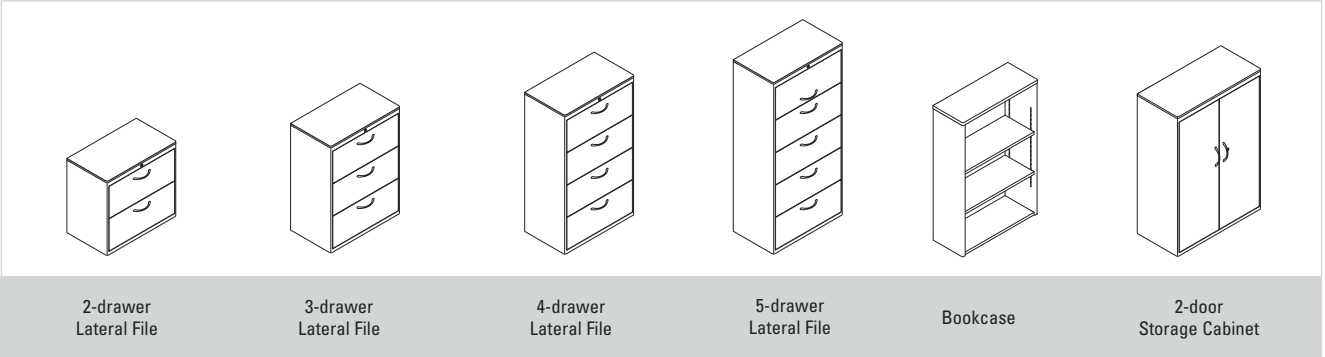

BOOKCASES, 2-DOOR CABINETS LATERAL FILES

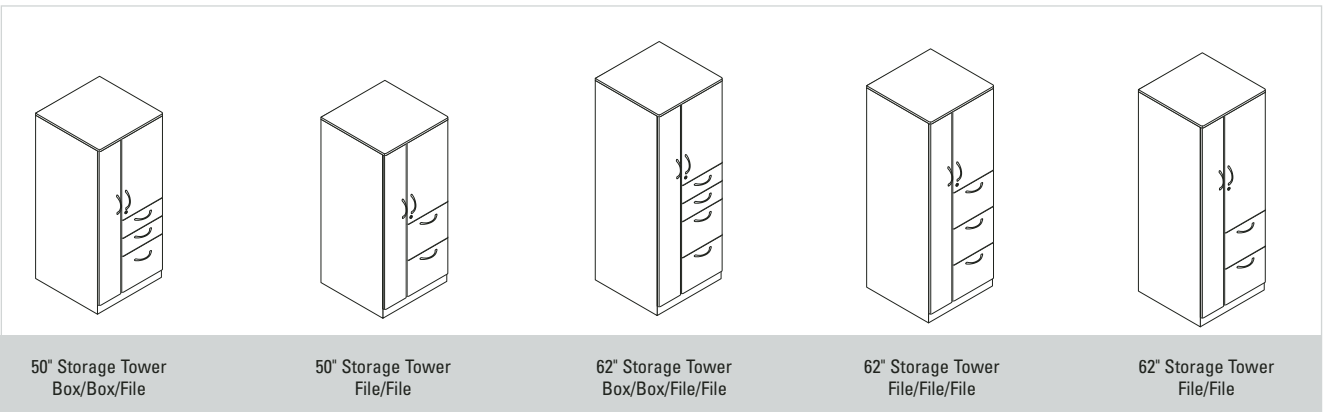

WARDROBE STORAGE TOWERS



THE STANDARD. FOR ANY ENVIRONMENT.

Matrix offers you an exceptional value for your work environment even as AIS sets a high standard for preserving and improving the world's environment. For several years, in fact, we have led our industry in developing and implementing Green and Lean manufacturing practices. A testament of our commitment is being the first and only systems furniture manufacturer to be awarded the prestigious Shingo Award for excellence in lean manufacturing. By working with like-minded suppliers, we have pioneered efforts in eliminating waste and reducing potentially harmful toxins and VOCs that could emit from our products. AIS also adheres to the stringent GREENGUARD standards and engineers and manufactures its products with this standard in mind. We will continue to devote ourselves to manufacturing lean products that are sensitive to the environment and human health.



Executive Interiors

**237 W. Main Street
Fredericksburg, Texas 78624**

0811

Ph. 1-830-990-4433

Fax 1-830-990-6688

Toll Free 1-800-808-4788

www.executiveinteriors.com